

Installation Instruction

AXIstorage Li SH

For Kostal PLENTICORE plus/BI



Inhalt



1	Safety.....	4
1.1	Important notes on this manual.....	4
1.1.1	Purpose.....	4
1.1.2	Target group.....	4
1.1.3	Storage.....	4
1.2	Symbol explanations.....	5
1.2.1	Explanations regarding safety instructions and warnings.....	5
1.2.2	Explanation of pictograms and symbols.....	6
1.3	Battery application area.....	7
1.3.1	Appropriate use.....	7
1.3.2	Perilous misuse.....	7
1.4	Main hazards.....	8
1.5	Qualification of the users.....	8
1.6	Personal protective equipment (PPE).....	9
1.7	Emergency instructions.....	9
1.7.1	Measures in case of fire.....	9
1.7.2	Measures after gases or liquids have escaped.....	9
1.7.3	Measures after electrical shock.....	9
2	Product description.....	10
2.1	Important information about the product.....	10
2.1.1	Conformity.....	10
2.2	Scope of delivery.....	11
2.3	Technical data.....	12
2.3.1	Performance features.....	12
2.3.2	Dimensions and weight of Energypack.....	12
2.3.3	Compatible inverters.....	12
2.3.4	Supply, interfaces, connections.....	12
2.3.5	Ambient conditions.....	13
2.4	Status und SOC Anzeige.....	13
3	Commissioning.....	14
3.1	Safety Instructions.....	14
3.2	Installation.....	14
3.2.1	Transport.....	14
3.2.2	Choice of installation site.....	14
3.2.3	Mounting.....	15

3.3	Assembly	15
3.3.1	Installing AXIstorage Li SH – Installation of Energypacks	15
3.3.2	Connect Energypacks next to each other in series	18
3.3.3	Closing the housing of the battery system	20
3.3.4	Subsequent installation of additional battery modules	20
3.3.5	Disposal measures	20
3.4	Connecting the inverter	21
3.4.1	Kostal PLENTICORE plus / BI	21
3.5	Putting the AXIstorage Li SH system into operation	23
4	Repair	23
5	Decommissioning, storage	23
5.1	Safety regulations	23
5.2	Storage conditions	24
5.2.1	Storage period	24
5.2.2	Physikcal conditions	24
5.2.3	Cleaning	24
6	Packing and transport	24
7	Disposal	25
8	Further directories	26
8.1	BMS Master, DC-DC converter and relay in AXIstorage Li SH	26
8.2	Assignment BMS master inverter interface	26
8.3	Voltage depending on SOC	27
8.4	Glossary	27
8.5	List of abbreviations	27
8.6	List of tables	27
8.7	List of figures	28
9	Addresses, identification and notes	28

1 Safety

Before installing the battery system, read these instructions carefully.

Please follow the safety and warning instructions carefully to avoid damage to persons, objects and the environment.

 	⚠ CAUTION
	<p>Risk of burns if you fail to adhere to the safety instructions.</p> <p>During operation, heat can be generated by live parts, overload, arc or short circuit. Touching hot surfaces can cause minor burns.</p> <p>▶ Read the operating instructions carefully before using the Energypack.</p>

1.1 Important notes on this manual

1.1.1 Purpose

This document describes the installation of an **AXIstorage Li SH** battery system in combination with Kostal PLENTICORE plus 3.0-10 or Kostal PLENTICORE BI 5.5/26 / 10/26.

The following items are compatible with both inverters:

AXIstorage LI SH (system housing), Item. No. 609812 / 610851

Energypack (battery module), Item. No. 607182 / 612033

1.1.2 Target group

The installation instructions are intended exclusively for qualified electricians.

1.1.3 Storage

This manual is part of the battery. For a safe installation, the manual must be accessible to the installers.

- Keep this manual near the battery.
- Pass this manual on to the next owner of the battery.

1.2 Symbol explanations

1.2.1 Explanations regarding safety instructions and warnings

Safety Instructions are universally valid and can be found in a safety chapter or at the beginning of a chapter.

Warnings are placed directly before behavioral guidelines. They help you to avoid dangers during an upcoming operation. They consist of the following elements:





Warning triangle	indicates all hazards with regard to death or injury along with a signal word.
Signal word	<p> DANGER</p> <p>denotes a hazard with a high degree of risk. Failure to avoid exposure to it will result in death or serious injury.</p> <p> WARNING</p> <p>denotes a hazard with a medium degree of risk. Failure to avoid exposure to it will result in death or serious injury.</p> <p> CAUTION</p> <p>denotes a hazard with a low degree of risk. Failure to avoid exposure to it will result in a minor injury.</p> <p> ATTENTION</p> <p>indicates hazard concerning objects. Failure to avoid exposure to it will result in damage to property.</p>
Type and source of the danger	states the nature of the danger and what causes it
Consequence	indicates what can happen if you do not follow the warning
Call for action	▶ describes what you must do to protect yourself from the danger
Additional symbols, pictograms	can be used in addition to the warning triangle. Warning signs (yellow) indicate the danger. Prohibition signs (red) and mandatory signs (blue) represent remedial measures.

Table 1: Warnings.

1.2.2 Explanation of pictograms and symbols

Symbols	Declaration
	General warning sign. Note additional information.
	Warning of electrical voltage.
	Warning of dangers from batteries that are being charged.
	Warning of flammable substances.
	Hot surface warning.
	Warning of hand injuries.
	No access for persons who have pacemakers or implanted defibrillators.
	Manual lifting prohibited.
	General commandment sign Note additional information.
	Adhere to instructions.
	Use foot protection.
	Use hand protection.
	Do not dispose of batteries with household garbage.

Table 2: Explanation of the symbols used

1.3 Battery application area

1.3.1 Appropriate use

The AXIStorage Li SH is a battery system. It serves as an energy storage device within an electricity storage system for private households and small businesses. It enables you to temporarily store self-produced electricity, e.g. from photovoltaic - or CHP (cogeneration of heat and power) plants. The electricity can later be used when needed.

In a battery system, 3 to 6 Energypacks can be connected to one another in series.

Axitec Energy GmbH & Co.KG is not liable for personal injury and/or material damage due to improper use of the energy storage system.

The battery system is a self-contained unit which is only functional after proper installation with an approved inverter.

A maximum of 6 Energypacks can be connected serially in the AXIStorage Li SH battery system.

In order to avoid dangers such as water pipe bursting, the Energypack must be stored at least 15 cm above the floor. Proper installation of the AXIStorage Li SH fire pump ensures that the active electrical components are at least 15 cm above the floor.

The AXIStorage Li SH battery system may:

- only be used with Energypack.
- only be used with compatible inverters.
- only be used in closed rooms.
- only be used in an undamaged condition and in accordance with the operating instructions.

Any other usage is not intended.

1.3.2 Perilous misuse

- Do not use the battery system with other Energypacks.
- Do not use the battery system outside its performance limits.
- Do not install the battery system in rooms at risk of flooding.
- Do not connect the battery system to devices not approved for this purpose.
- Do not open Energypack. The Energypack may only be opened by trained service personnel.

1.4 Main hazards

You can expect zero danger from the battery under normal conditions. The battery corresponds to the state of the art in science and technology. However, it is obviously impossible to completely exclude risks if the battery is misused or in the event of technical failure. In case of lithium-ion batteries, these generally include fire, explosion, chemical burns and electric shock.

The product-specific risk of hazards is elevated by

- Water (e.g. flooding)
- Heat exposure (> 70 °C)
- Failure or malfunction of the control system due to electromagnetic radiation

Touching live components may cause an electric shock when Energypacks are connected in series. The electric shock can have thermal or muscle paralyzing effects. The latter can lead to ventricular fibrillation, cardiac arrest or respiratory paralysis, or death.



Electric shock

Overload, short circuit or arcing can cause a lithium-ion fire with thermal runaway. People can be hit by electrolyte or molten material. In the event of fire, there is a risk of suffocation due to lack of oxygen and a risk of poisoning due to toxic fumes.



Fire

1.5 Qualification of the users

Only the electricians qualified by the Axitec Energy or the Axitec Energy itself may work with the battery system.

Do not leave the children unattended or allow them to be near the battery system.

High currents have effects on medical implants.

- People with implants must be careful not to be in the direct vicinity of the battery during operation.

People with implants



1.6 Personal protective equipment (PPE)

Use foot protection and hand protection during assembly.

1.7 Emergency instructions

1.7.1 Measures in case of fire

Do not inhale smoke and vapors.

Report a lithium-ion fire to the fire department.

If possible: Close the doors.

If possible: Cool the Energypack with water. Avoid contact with the extinguishing water!

1.7.2 Measures after gases or liquids have escaped

Escaping gases can cause respiratory problems.

- Ventilate immediately or go out into the fresh air, in more extreme cases, call a doctor immediately.

Skin contact may cause skin irritation.

- Wash skin thoroughly with soap and water.

Eye contact may cause irritation to the eyes.

- Immediately rinse eyes thoroughly with water for 15 minutes, then consult a doctor.

1.7.3 Measures after electrical shock

Ensure that the system is at zero voltage.

- **For unconscious patients:** Ensure respiration and cardiovascular function. If necessary, initiate cardiopulmonary resuscitation immediately.
- **For responsive patients:** Cool burn injuries and cover them by dressing the wound.

2 Product description

2.1 Important information about the product

Overall view

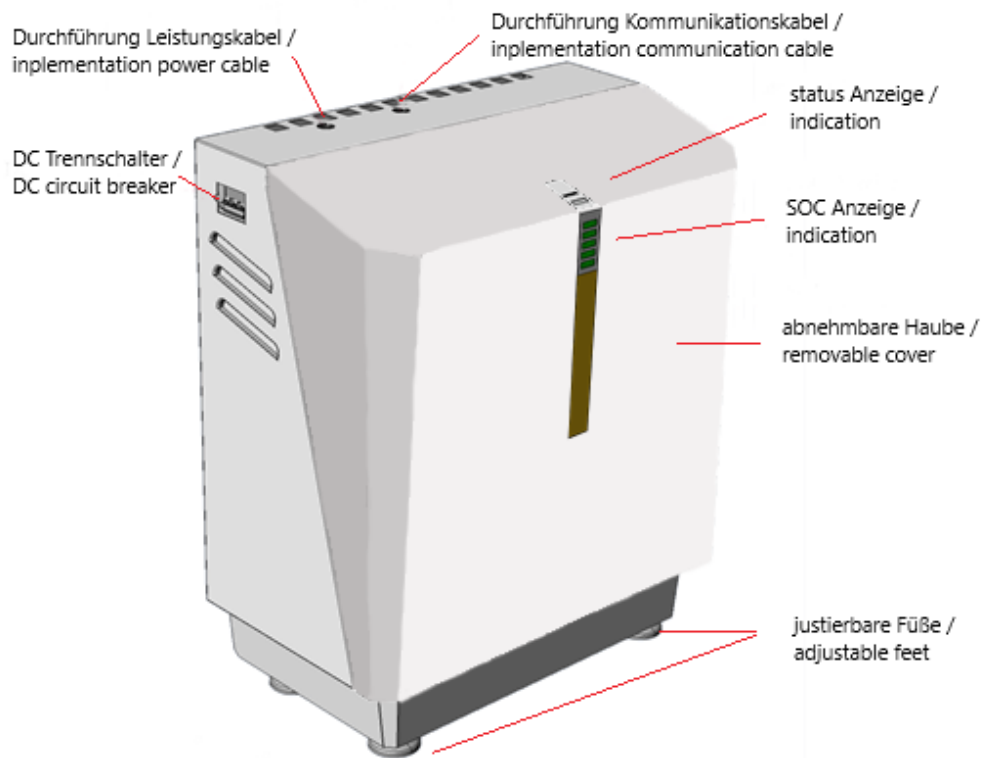

Figure 1
Overall view of battery system.

2.1.1 Conformity

The following standards, laws and guidelines were taken into account during the development of the Energypack:

- EU directive with CE labelling obligation
 - Low Voltage Directive 2014/35/EU
 - EMC Directive 2014/30/ EU
- Legal requirements
 - UN transport test (lithium systems)
- Standards and user guidelines
 - DIN EN 60730
 - DIN EN 62619

2.2 Scope of delivery

- AXIstorage Li SH system housing
- Installation kit (in system housing) is included:
 - 7 RJ45 patch cables **A**
 - 12 screws M5x10 **B**
 - 3 Dummy sockets, power plugs **C**
 - 2 PG connections **D**
 - 1 Three-hole cable bushing **E**
 - 1 Single-hole cable bushing **F**
 - 1 Ferrite core **G**

Installation kit:



ATTENTION

Not included with the system housing

- Installation instructions
This can be downloaded at www.axitecsolar.com in the download area.
- 3 to 6 Energypacks
The number of Energypacks must be ordered separately depending on the selected performance and may only be installed / put into operation by qualified electricians.

2.3 Technical data

2.3.1 Performance features

Modules in series	3	4	5	6
Energy content (nom./usable)	9,7 kWh / 7,5 kWh	12,9 kWh / 10 kWh	16,1 kWh / 12,5 kWh	19,3 kWh / 15 kWh
Nominal voltage	155 V	207 V	258 V	310 V
End-of-charge voltage	170 V	227 V	284 V	340 V
Final discharge voltage	134 V	179 V	224 V	268 V
Capacity (nom.)	62,7 Ah	62,7 Ah	62,7 Ah	62,7 Ah
Charging current (continuous.)	29 A	29 A	29 A	29 A
Discharge current Peak	40 A	40 A	40 A	40 A
Discharge power Peak	6,2 kW	8,3 kW	10,3 kW	12,4 kW
Discharge capacity (max.)	4,6 kW	6,2 kW	7,7 kW	9,3 kW
Dimensions (B x H x T)	751 mm x 870 mm x 423 mm	751 mm x 870 mm x 423 mm	751 mm x 870 mm x 423 mm	751 mm x 870 mm x 423 mm
Weight	107 kg	129 kg	151 kg	173 kg
Discharge operating temperature	-15 to 55 °C	-15 to 55 °C	-15 to 55 °C	-15 to 55 °C
Load operating temperature	0 to 45 °C	0 to 45 °C	0 to 45 °C	0 to 45 °C
Storage temperature	-20 to 60 °C	-20 to 60 °C	-20 to 60 °C	-20 to 60 °C
Battery chemistry	Li-Ion NMC			
Discharge depth	80 % DOD [in relation to nom. capacity]			
Full Cycles	5 000 or 3 000 (for residual capacity of 60 % or 80 %)			

Table 3: Technical data

2.3.2 Dimensions and weight of Energypack

- Dimensions (W x H x D): 546.1 mm x 216,8 mm x 155.25 mm
- Weight: 22 kg

2.3.3 Compatible inverters

- Kostal PLENTICORE plus 3.0-10 (RS-485)
- Kostal PLENTICORE BI 5.5/26 / 10/26 (RS-485)

2.3.4 Supply, interfaces, connections

The AXIStorage Li SH is supplied with the following connections:

- + DC cable: AWG8 red (American standard for wire cross section)
- - DC cable: AWG8 black
- Cable for grounding: AWG8 yellow-green
- Communication cable, either CAN or RS-485

All cables have a length of about 40 cm.

NOTE: Extension of the power cables must not exceed the following lengths:

- 6 mm² cable cross section: 4,5 m
- 10 mm² cable cross section: 7,5 m

The Energypack has one socket which contains (+) and (-) as power contacts and two RJ45 sockets which contain CAN bus and status and signal lines:

- 1 socket with power contacts (+) and (-)
- 1 RJ45 sockets with CAN bus connection for monitoring and control of the Energypacks by the higher-level controller (IN)
- 1 RJ45 socket for connecting a further Energypack (OUT)
- 2 M5 threads for connecting the grounding

2.3.5 Ambient conditions

Operation exclusively inside buildings (air-conditioned and non air-conditioned interiors):

- Temperature: 0 ... 45 °C
- Relative humidity: 5 ... 85 %
- Height: 0 ... 2000 m above sea level.
- Temperature Storage: -20 ... 60 °C

2.4 Status und SOC Anzeige

During operation 6 LED fields indicate the status and SOC of the battery system.

Status LED	10 Sekunden	Erklärung
green – lights up		unloading
green - flashing (0,5 s on and 1 s off)		ready (Batterie relay energized – waiting for charging or discharging)
green – flashing slowly (1s on 5 s off)		Standby (battery system relay open)
blue – lights up		loading
blue - flashing (0,5 s on und 1 s off)		Diagnosis or shutdown of the battery system
blue – flashing slowly (1s on 5 s off)		System start, relay test or software update
red – flashing fast (0,2 s on 0,2 s off)		System error - System has disconnected battery from inverter
red – flashing (0,5 s on und 1 s off)		Error during start-up of the battery system - battery remains disconnected

Table 4: Overview LED status codes

3 Commissioning

3.1 Safety Instructions

The installation may only be carried out by qualified electricians according to IEC 60204-1 (International Electrotechnical Commission).

The housing including electronics weighs 41 kg. One Energypack weighs 22 kg. Heavy lifting can cause a disturbance of the musculoskeletal system.

- Lifting the AXIstorage Li SH cover (11 kg) and base (30 kg) separately
- If and as necessary, do not lift the AXIstorage Li SH base alone or be sure to use transport aids.

Risk of crushing and abrasions when lifting and inserting the Energypack.

- Use foot and hand protection.



3.2 Installation

3.2.1 Transport

If the installation site is difficult to access, it is recommended that the base and the hood of the system housing be carried to the installation site separately:

Open the packaging of the AXIstorage Li SH system housing.

Unscrew 2 screws (hexagon socket, SW4) at the front of the bottom of the system housing

Remove the hood from the system housing base.

Carry the hood and base to the installation site individually.

The Energypacks should be transported to the installation site in their original packaging.

3.2.2 Choice of installation site

The battery system can be mounted upright on the floor.

It is recommended that the inverter is installed on the floor against a wall, where it can be mounted centrally above the battery system. The inverter should be mounted at least 20 cm above the battery system. At a distance of up to 30 cm, the cables already attached to the AXIstorage Li SH can be used. Leave space of at least 30 cm free to the left and right of the battery system to get to the DC disconnect switch to ensure sufficient air circulation.

To prevent the battery system from tipping over, it can be secured to the installation wall with two screws (not supplied). Two fixing points are provided in the system housing for this purpose.

Four fixing points are provided in the system housing for wall mounting. Since the battery system can weigh up to 173 kg, it must be checked in advance whether the wall and fastening material are suitable to support the load in the long term.

3.2.3 Mounting

The installation location for the battery system and the inverter have been determined.

Recommended mounting:

1. Install the wall bracket of the inverter.
2. Hook the inverter into its bracket.
3. Unscrew the cover of the connection area.
4. If not already done, remove the cover from the battery system housing:
 - ⇒ Unscrew 2 screws (hexagon socket, SW4) on the front underside.
 - ⇒ Remove the cover from the base.



Position the base of the battery housing at the intended installation location (and screw it on if necessary).

3.3 Assembly

3.3.1 Installing AXIStorage Li SH – Installation of Energypacks

Safety Instructions

⚠ CAUTION	
	<p>Risk of crushing due to improper installation.</p> <p>Falling or improper insertion of the module can cause slight bruising and abrasions to hands and feet.</p> <ul style="list-style-type: none"> ▶ Wear protective clothing.

	⚠ CAUTION
	<p>Ergonomic hazards due to heavy lifting.</p> <p>Lifting the Energypack can cause a disturbance of the musculoskeletal system.</p> <ul style="list-style-type: none"> ▶ Should it be necessary, be sure not to lift the module alone. ▶ Use a lifting aid, when necessary.

ATTENTION
<p>Incorrect installation due to damaged or contaminated Energypack.</p> <p>Only faultless modules may be mounted. The housing must be undamaged. The contact points must be undamaged and clean.</p> <ul style="list-style-type: none"> ▶ Perform a visual inspection. ▶ Clean the contact points with a dry cloth if necessary.

The Energypack may only be inserted into the AXIstorage Li SH battery system provided for this purpose.

- ✓ The power storage system is securely installed.
 - ✓ The main switch of the power storage system is off.
 - ✓ The Energypacks should have a similar voltage
 - ✓ The inverter is not yet connected or switched off
1. Make sure that the DC disconnecter of the AXIstorage Li SH is set to "off".
 2. Loosen the two screws **H** and **I**, with which the hold-down is fixed on the left and right, and lift up the downholder.

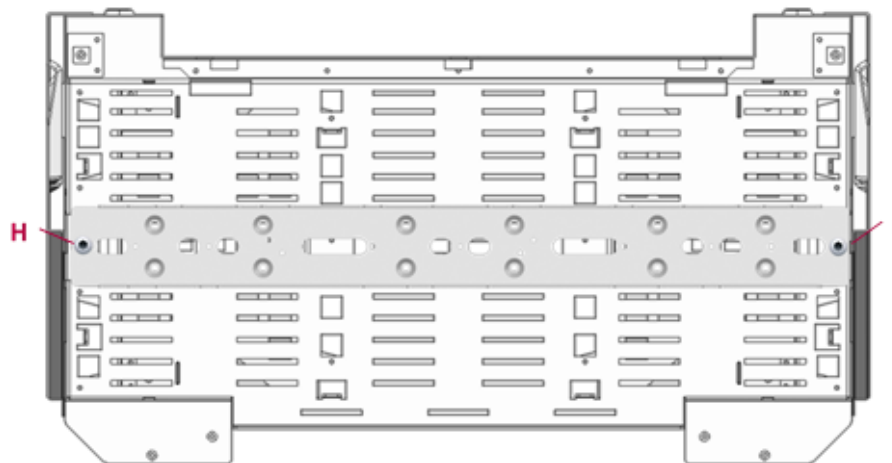

3. Unpack and insert the Energypack.

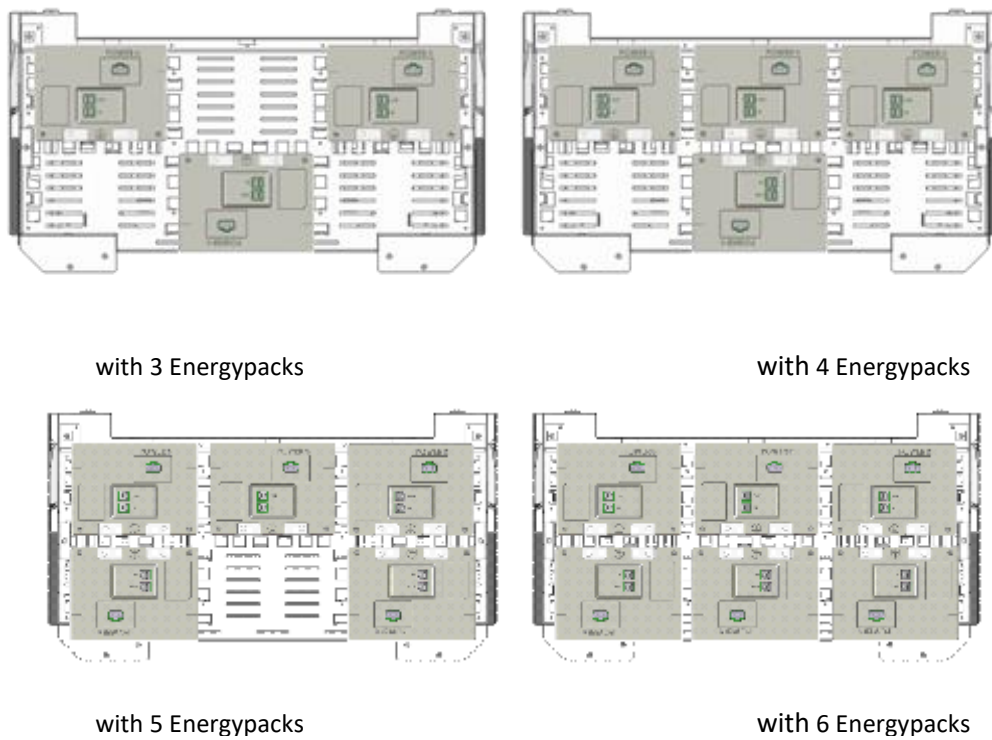

Figure 2: Insert 3 to 6 Energypacks

NOTE: For best cooling, we recommend that you install the battery modules as shown in Figure 2.

4. Screw the downholder to the right and left of the base of the system housing.
5. Screw each Energypack with two screws (M5) to the downholder/grounding support. For example, refer to Figure 3.

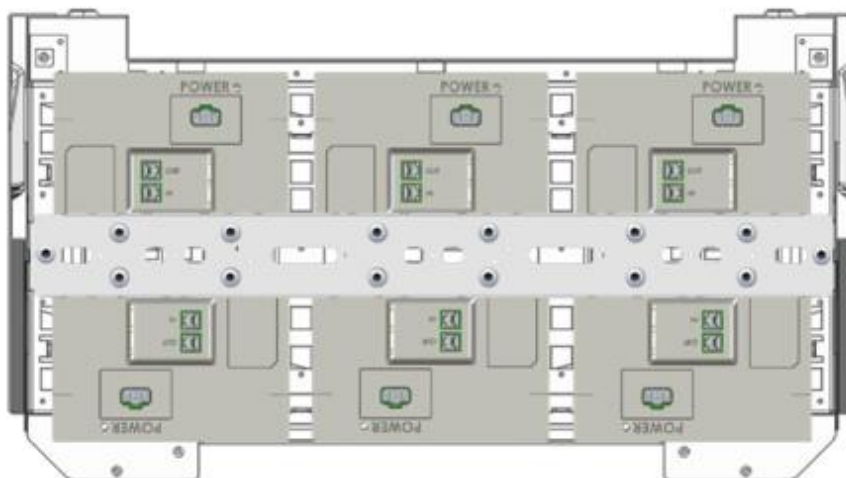

Figure 3: Energypacks fixed to the grounding support

6. Use the patch cables to connect the BMS master (left of the two RJ45 sockets) with the installed Energypack.
For example, refer to

Figure 4.

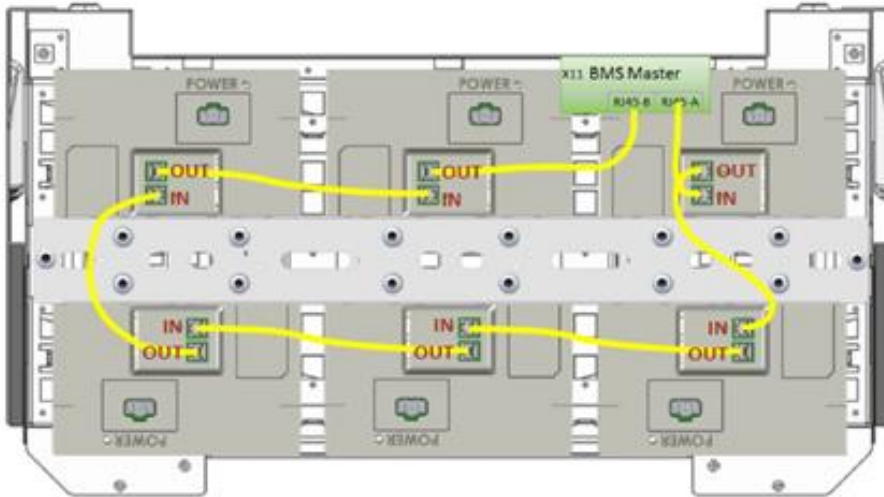



Figure 4: Connect the Energypack to the BMS master using the patch cables

7. connect the last battery module to the left RJ45 socket (RJ45-B) in the BMS master.

3.3.2 Connect Energypacks next to each other in series

 WARNING	
	<p>Electric shock from live parts.</p> <p>Touching live components may cause electrical shock, which may create intense heat or paralyze muscles. The latter can lead to ventricular fibrillation, cardiac arrest or respiratory paralysis, or death.</p> <p style="text-align: center;">▶ Never touch the contacts.</p>

1. Remove the safety cover of the "Power" sockets.

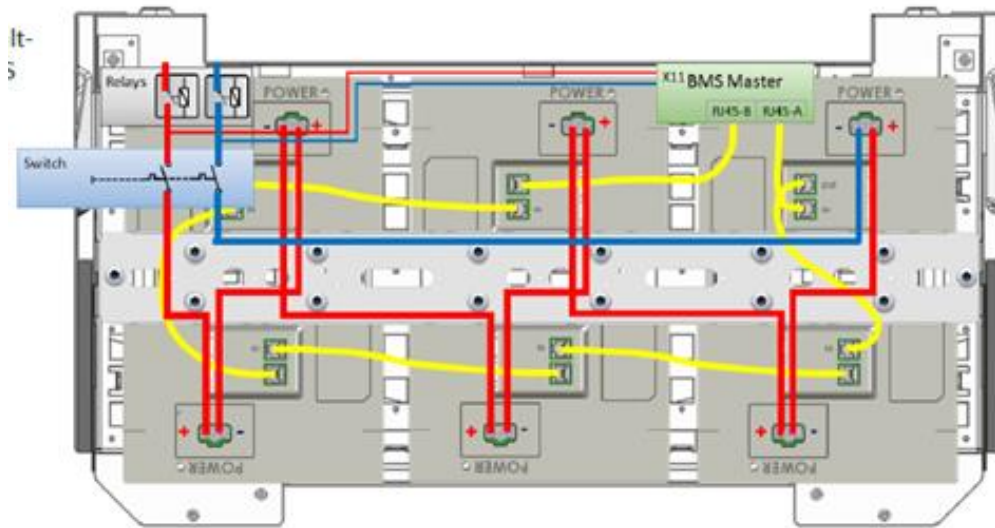

Figure 5: Power path with switching devices and BMS

2. Insert the power plug for the respective Energypack until it clicks into place. For example, refer to Figure 5.
3. Check by pulling the power plugs to make sure that the latching is engaged.
4. If there are less than 6 Energypacks: Fit the power plugs not required with the dummy sockets **C** supplied.
5. Feed the power cables (red and black) as well as PE (yellow-green) through the left hole in the basic housing and fix them with the supplied PG screw connection.
NOTE: Feed the cables first through the union nut of the PG gland and then through the outer housing.



6. above the left PG gland, lead the red (+) and black (-) cable through the supplied ferrite core **G**.
7. Lead the communication cable through the right hole and fix it with the supplied cable gland.



3.3.3 Closing the housing of the battery system

1. Position the housing hood (with display) in front of the housing base and plug the cable for the display on the board into the hood.
2. Insert the hood into the guide at the top and close it at the bottom with the two M5x10 hexagon socket screws (SW4) which were unscrewed in 3.2.3.



3.3.4 Subsequent installation of additional battery modules

1. check the voltage of the modules. This should be between 46 V and 56 V.
2. adjust the voltage of the battery system to ± 1 V for the new modules. An exactly adjusted module voltage avoids system voltage adjustment and allows immediate access to the entire capacity.
3. disconnect the inverter and switch off Hyperion.
4. Install new modules. See chapter 3.3 Installation.
5. put the system into operation. See chapter 3.4.

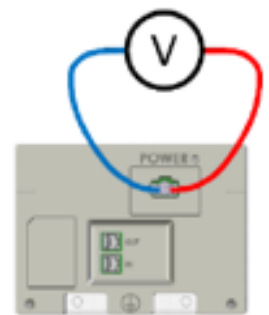

3.3.5 Disposal measures

Dispose of transport packaging for recycling in accordance with the statutory provisions.

It is recommended to keep not required parts (patch cables, dummy plugs, screws) together with the installation instructions near the battery system.

Before removing defective Energypacks, the power socket must be taped with insulating tape after removing the power plug.

3.4 Connecting the inverter

3.4.1 Kostal PLENTICORE plus / BI

1. In order to operate the AXIstorage Li SH system communicatively with the Kostal PLENTICORE plus / BI, the communication must be switched to RS485.

- ✓ Disconnect the X2 plug from the BMS master (green plug at top left)
- ✓ Yellow wire must be re-pinned from PIN1 to PIN3 (RS485+)
- ✓ White wire must be re-pinned from PIN2 to PIN4 (RS485-)
- ✓ PIN5 and PIN7 must be bridged to activate the RS485 communication
- ✓ Plug X2 back into BMS master

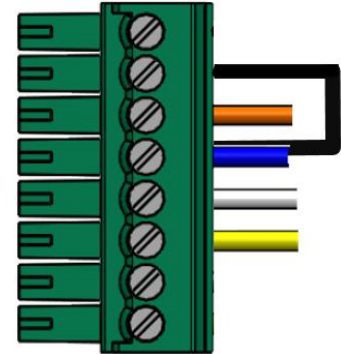

2. Preparation: Ground the AXIstorage Li SH housing:

- ⇒ PE
 - Yellow-green Connect to grounding rail

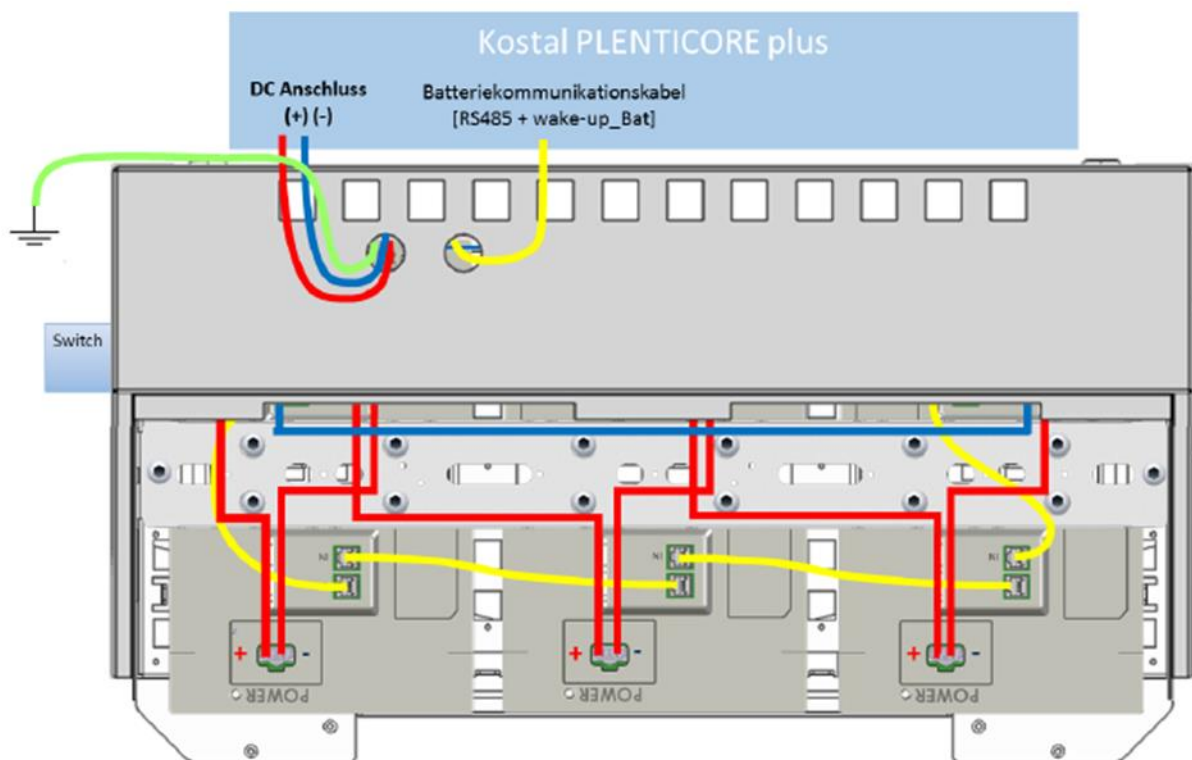

Figure 6: Connecting the PLENTICORE to the AXIstorage Li SH

3. Feed the communication cable through the respective PG screw connections into the connection compartment of the inverter.

4. Connect the cables in/on the inverter according to the PLENTICORE operating instructions.

⇒ Connecting battery communication cable:

- white: RS485B
- yellow: RS485A
- blue: GND 0V
- orange: wake-up_Bat

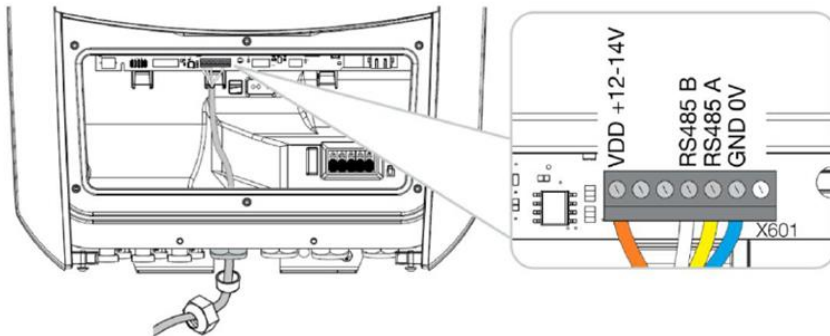

Figure 7: Connection of the PLENTICORE plus/BI - communication cable

5. Shut the inverter down

6. Establish DC connection:

⇒ Attach Sunclix plug accordingly

- Red (+) (DC3 +)
- Black (-) (DC3 -)

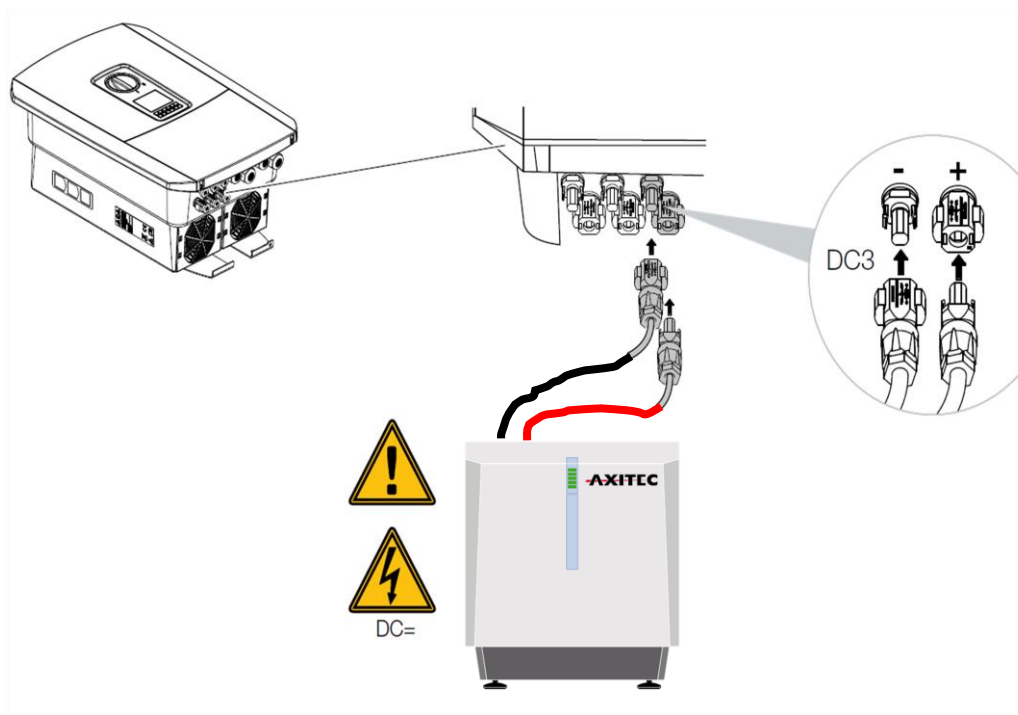

Figure 8: Connection of the PLENTICORE plus/BI - DC connection

7. Check all electrical connections.

8. Close the housing of the inverter.

3.5 Putting the AXIstorage Li SH system into operation

1. Put the inverter into operation
2. Set up inverter communication so that battery system can be set up
3. Switch the DC disconnecter on the left side of the AXIstorage Li SH to "on".
4. Commission the storage system according to the operating manual of the connected inverter.

4 Repair

The Energypack may only be opened and repaired by the manufacturer.

Defective Energypack may only be send back in consultation with the manufacturer or a company commissioned by the manufacturer to the address provided by him.

Apart from the modules, the battery system can be repaired by trained specialists using original spare parts.

5 Decommissioning, storage

5.1 Safety regulations

WARNING

Health hazard due to deep-discharging.

After more than six months of storage, the battery cells can be deeply discharged. This can lead to chemical reactions within the cells, which result in the development of heat and gas, as well as possible health hazards.

- ▶ Recharge the module every six months.

- Disconnect inverter from voltage.
- Switch off the DC switch on the left side of the AXIstorage Li SH battery system. Open the AXIstorage Li SH and unlock and disconnect both the patch cables and the power cables on the Energypacks.
- Mask the power socket with insulating tape.
- All current legal fire protection requirements must be met. In case of doubt, contact your local fire brigade and your insurance agency.
- Store the Energypack in a dry place, protected from sunlight.
- If the Energypack has been in water or any other liquid, it must not be put back into operation.

5.2 Storage conditions

5.2.1 Storage period

Do not store the module for more than six months from the date of manufacture (see type label). The module must be recharged for longer storage periods.

5.2.2 Physikal conditions

Store the module in a dry place, protected from solar radiation, maximum 2000 m above sea level.

The following conditions should prevail on an average:

- Temperature: 15 ... 25 °C
Tough limits:
Storage: -10 ... 50 °C
Transport: -20 ... 60 °C
- Relative humidity: 0 ... 50 %

No more than 4 Energypacks may be stacked on top of each other.

Store Energypack at least 15 cm above the floor to reduce the risk of water damage.

5.2.3 Cleaning

Before storage, remove dust and other deposits from the battery system. Either by vacuuming and/or with a damp cloth.

6 Packing and transport

The Energypack may only be shipped in suitable packaging that is labelled in accordance with legal requirements and accompanied by the accompanying documents.

If still available and intact, the delivery packaging can be used.

If not, please contact the manufacturer or the company commissioned by the manufacturer.

7 Disposal

Batteries may not be disposed of in household garbage. As a consumer, you are legally obligated to return used batteries. The return is free of charge.

If lithium batteries are not disposed of properly, fire or leakage of hazardous substances may cause damage to health and the environment.

Please contact the manufacturer or the company commissioned by the manufacturer when the Energypack has reached the end of its service life.

The manufacturer shall send used batteries for recycling in accordance with their electrochemical system. Valuable raw materials are recycled and hazardous substances are disposed of properly. Returning these materials makes a valuable contribution to protecting our environment.

8 Further directories

8.1 BMS Master, DC-DC converter and relay in AXIstorage Li SH

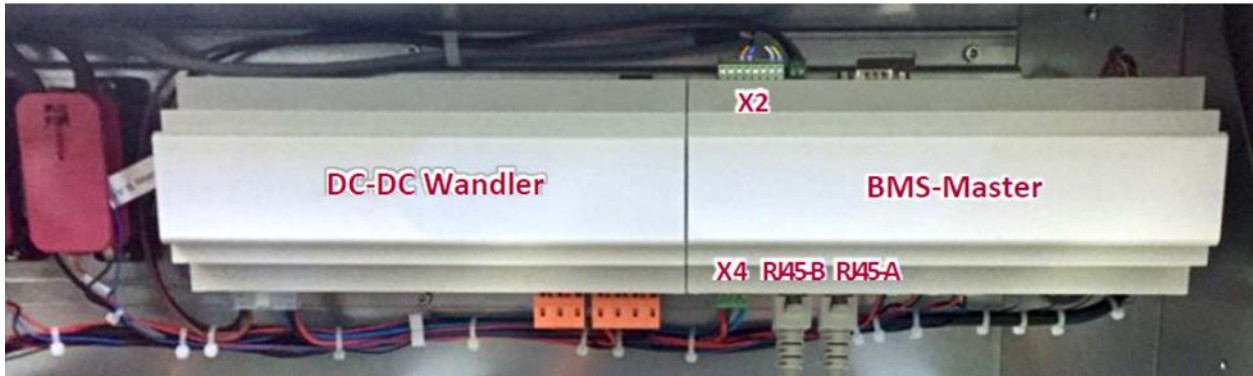

8.2 Assignment BMS master inverter interface

AXIstorage Li SH		Kostal PLENTICORE plus/BI	
Pin	assignment	Pin	strand colour [X601]
1	CAN H	n.c.	n.c.
2	CAN L	n.c.	n.c.
3	RS485A	5	yellow
4	RS485B	4	white
5	GND	6	blue
6	Enable (12 V, 10 mA)	1	orange
7	Jumper RS485	n.c.	n.c.
8	./.	n.c.	n.c.

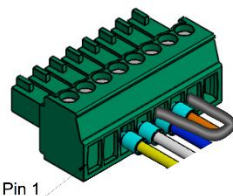

Bridge between Pin 5 and 7 defined RS485 and Protocol for the operation with Kostal PLENTICORE plus/BI

Table 5: Pin assignment of X2 for and Kostal PLENTICORE plus/BI

8.3 Voltage depending on SOC

Voltage	System voltage with number of serial battery modules				
	SOC	3	4	5	6
46.3 V	0%	138.9 V	185.2 V	231.5 V	277.8 V
47.8 V	10%	143.5 V	191.3 V	239.1 V	287.0 V
48.8 V	20%	146.4 V	195.2 V	244.1 V	292.9 V
49.7 V	30%	149.1 V	198.8 V	248.5 V	298.2 V
50.5 V	40%	151.5 V	202.0 V	252.5 V	302.9 V
51.5 V	50%	154.4 V	205.9 V	257.4 V	308.9 V
52.7 V	60%	158.0 V	210.6 V	263.3 V	315.9 V
53.6 V	70%	160.9 V	214.6 V	268.2 V	321.9 V
54.8 V	80%	164.5 V	219.3 V	274.1 V	329.0 V
55.9 V	90%	167.7 V	223.6 V	279.6 V	335.5 V
56.7 V	100%	170.1 V	226.8 V	283.5 V	340.2 V

Table 6: OCV and SOC of the Energypack and the AXIstorage

8.4 Glossary

Term	Definition
User	Individual who uses the product
Specialist	An individual who, based on his or her relevant professional education, training and/or experience, is capable of identifying risks and preventing hazards arising from the use of the product.
Hazard	Potential source of damage
Damage	Physical injury or damage to the health of persons, or damage to property or the environment
Thermal runaway	Chemical process that is triggered by heat and generates additional heat.

8.5 List of abbreviations

Term	Definition
BMS	Batterie Management System
PPE	Personal protective equipment
CHP	Combined heat and power
OCV	Open circuit voltage
SOC	State of charge

8.6 List of tables

Table 1: Warnings.	5
Table 2: Explanation of the symbols used.....	6
Table 3: Technical data	12

Table 4: Overview LED status codes.....	13
Table 5: Pin assignment of X2 for and Kostal PLENTICORE plus/BI.....	26
Table 6: OCV and SOC of the Energypack and the AXIstorage.....	27

8.7 List of figures

Figure 1 Overall view of battery system.	10
Figure 2: Insert 3 to 6 Energypacks	17
Figure 3: Energypacks fixed to the grounding support	17
Figure 4: Connect the Energypack to the BMS master using the patch cables	18
Figure 5: Power path with switching devices and BMS	19
Figure 7: Connecting the PLENTICORE to the AXIstorage Li SH	21
Figure 8: Connection of the PLENTICORE plus/BI - communication cable.....	22
Figure 9: Connection of the PLENTICORE plus/BI - DC connection.....	22

9 Addresses, identification and notes

Imprint	Axitec Energy GmbH & Co. KG Otto-Lilienthal-Straße 5 71034 Böblingen Germany Tel.: +49 (0) 7031 6288-5186 energy@axitecsolar.com
Product- identification	AXIstorage Li SH (system housing) Energypack (modular battery)
Document- identification	Original installation instructions AXIstorage Li SH Version: V210714EN (based 1.2f) State: 14.07.2021